

Limit-value switch, input AC-voltage

- Straightforward application
- Suitable for severe operating conditions
- Compact construction
- Limit value freely adjustable by drum scale
- Anti-tamper seal for drum scale
- Meet high EMC-requirements
CE requirements
- Volt-free output as change over switch contact or make-contact
- Open-circuit or closed-circuit variants available
- Test function to simulate an increased sensor signal without critical machine loading
- Optionally with latching function (only open circuit devices)
- Operating characteristics displayed by integrated LEDs
- Flame-inhibiting and self-extinguishing body
- Suitable sensors are available (NORIS GE.. devices)

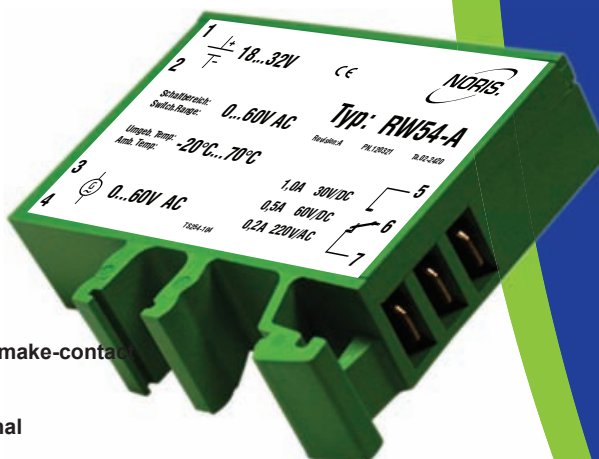
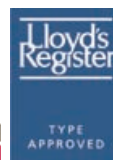

Image
RW54-A



Germanischer Lloyd

Limit-value switches of series 5

Limit value switches of the series 5 are designed to monitor and process electric measured variables.

Working principle: When the actual value of the measuring signal supplied reaches the setpoint, the built-in relay will operate. The switching status of the relay contact may, for instance, be monitored or individually processed by a machine controller.

General notes on Type RW5..

Description RW5..

- Designed to monitor an alternating voltage
- Various devices available for optimal matching to input signal
- Limit value settings possible over complete input range by means of drum scale

Volt-free relay contact, closed-circuit or open-circuit version

A volt-free relay contact is provided as a change over switch contact for outputting and further processing. In addition, there is a choice between closed-circuit and open-circuit devices.

In the case of closed-circuit devices, the output relay is pulled up in the normal state of operation with the supply voltage applied. It drops off upon the limit-value being exceeded or if the supply voltage fails.

In the open-circuit variant, the output relay pulls up when the limit-value is exceeded with the supply voltage applied. Failure of the voltage will not result in any switching function below the limit value.

Test function for open circuit devices

The Types RW5..-S have the integrated special functions testing and latching. The Types RW5..-A2 have only the special function testing. The testing function offers while the contacts 2 and 5 are connected, the limit-value signal selected on the drum scale is lowered by about 15%. In a speed monitoring application, this means that an overspeed condition can be simulated within the normal range without running the machine in the critical range.

Latching function for open circuit devices

Open circuit devices can optionally be equipped with a latching function (see type code). When the limit value is exceeded, the relay keeps activated even if the signal falls below the limit value afterwards. The device has to be reset by disconnecting the supply voltage.

Technical Data

Series RW5..., RW5...-S	
Supply voltage	$U_s=12 \dots 32$ V/DC, $U_R=24$ V/DC
Ripple	$< 20\%$ U_s
Reverse voltage protection	Integrated
Overvoltage	2.5 times U_n up to 2 ms
Voltage drops	100% up to 10 ms
Power consumption	Approx. 50 mA (24 V/DC)
Galvanic isolation	Between input signal and supply voltage
Input signal	AC-voltage, NORIS tachogenerator GE
Input overloading	< 1.5 times maximal input
Input resistance	RW53.. approx.30 k Ω , RW54.. approx.60 k Ω , RW55.. approx.90 k Ω
Output contact	Volt-free change over switch contact, closed circuit or open circuit (RW5..) Volt-free NOC, closed circuit or open circuit (RW5...-A2, RW5...-S)
Maximal switching capacity	30 W (1 A at 30 V/DC; 0.5 A at 60 V/DC) 40 W (0.2 A at 220 V/AC)
Limit value	Adjustable on tamper-proof drum scale between 2 ... 20 V/AC for RW53..., 6 ... 60 V/AC for RW54..., 9 ... 90 V/AC for RW55..
Reproducibility	$< \pm 0.2\%$
Linearity of scale	$< \pm 1.5\%$
Hysteresis	Approx. 1.5%
Test function	Connect 2/5 to lower limit value approx. 15% (only RW5...-S/RW5...-A2)
Latching function	Relais is held till supply voltage is interrupted min. 500 ms (RW5...-S)
Error class	IEC51-1 1.5%
Temperature sensitivity	$< \pm 0.1\%$ je 10°K
Voltage sensitivity	$< \pm 0.1\%$ for 10% change in supply voltage
Reaction time	< 300 ms
Measuring suppression	Approx. 2 s after turning on the supply voltage
Vibration resistance	IEC60068-T2-6 15g increased strain, characteristic 2 (10 ... 100 Hz)
Shock resistance (impact)	DIN IEC60068-T2-27 300 m/s ² with 18 ms dwell time
Climatic test	IEC60068-T2-30
Operating temperature	$-20^\circ\text{C} \dots +70^\circ\text{C}$
Storage temperature	$-45^\circ\text{C} \dots +85^\circ\text{C}$
Humidity	RH 96% maximum
ESD	IEC61000-4-2 ± 8 kV
Electromagnetic field	IEC61000-4-3 10 V/m $f=10$ kHz ... 2000 MHz, 80% AM @ 1 kHz 10 V/m $f=900 \pm 5$ MHz, 50% AM @ 200 Hz 10 V/m $f=1800$ MHz ± 5 MHz, 50% AM @ 200 Hz
Burst	IEC61000-4-4 ± 2 kV supply ± 1 kV sensor
Surge	IEC61000-4-5 sym. ± 1 kV ($R_f=2 \Omega$) asym. ± 2 kV ($R_f=2 \Omega$)
HF-susceptibility	IEC61000-4-6 3 V _{pp} 80% AM @ 1 kHz $f=0.01 \dots 100$ MHz
LF-susceptibility	IEC60553 3 V _{pp} 0.05 ... 10 kHz
Interference field intensity	Basis CISPR 16-1, 16-2 reduced characteristic
Connection	DIN46244 flat connector, gold-plated A6.3 x 0.8
Protection class	DIN EN60529 Body IP20, terminals IP00
Mounting	Snap-fit on top-hat channel or G-channel
Installed position	Any
Body material	Thermoplastic polyester, green, fire protection class V0
Weight	55 g
Applied standards	CE requirements complied with, DIN EN 61000-6-2, DIN EN 61000-6-4, DIN EN 50155, approved by GL, BV, LR, DNV

Type key / variants

Input range	2 ... 20 V/AC	6 ... 60 V/AC	9 ... 90 V/AC
Change over switch in closed current	RW53	RW54	RW55
Change over switch in open-circuit current	RW53-A	RW54-A	RW55-A
NOC in open-circuit current with test function and latching function	RW53-S	RW54-S	RW55-S
NOC in open-circuit current with test function	RW53-A2	RW54-A2	RW55-A2

Device codes

R	Limit-value switch
W	Input signal
W	AC-voltage
5	Type series
5	Type 5
3	Input range
3	2 ... 20 V/AC
4	6 ... 60 V/AC
5	9 ... 90 V/AC
A	Output contact as change over switch contact in closed current
A2	Output contact as change over switch contact in open-circuit current
S	Output contact as NOC in open-circuit current with test function and latching function

R W 5 3 - A (RW53-A)

Other Data

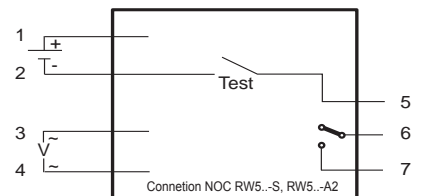
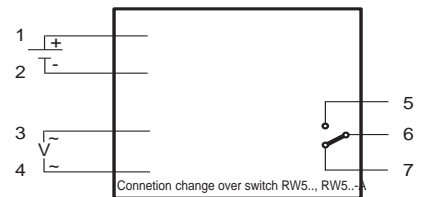
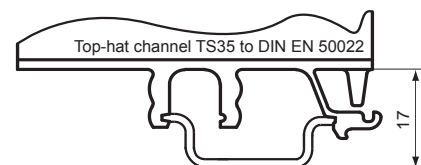
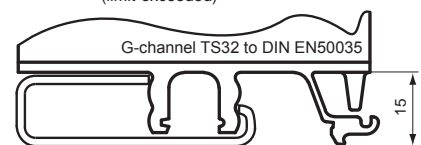
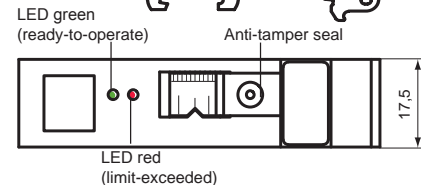
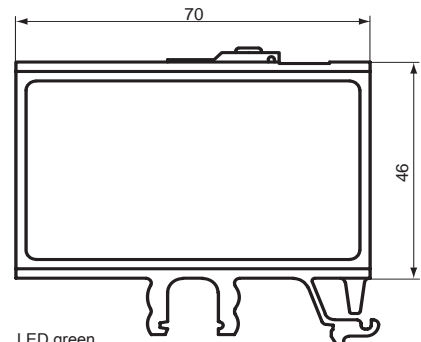

Relay position

RW5...	RW5...	RW5...	RW5...-A	RW5...-ARW5...-A2	RW5...-S
Terminal	6/7	5/6	6/7	5/6	6/7
U < limit value	-	x	x	-	-
U > limit value	x	-	-	x	x (*)

x = contact closed

- = contact open

(*) = Latching function: as -A2, but relay keeps open until U_s is disconnected

The red LED is illuminated, if the limit value is exceeded



NORIS Automation GmbH
Muggenhofer Strasse 95
90429 Nuremberg
Germany

Tel.: +49 911 3201-220
Fax: +49 911 3201-150
sales@noris-group.com
www.noris-group.com