

Non-contacting two-channel speed sensor FAHZ5 with signal amplifier, difference-hall-effect principle



Scan type:	Non-contacting Ferromagnetic materials Direction-sensitive
Frequency range:	0.2 ... 20,000 Hz
Supply voltage:	9 ... 32 VDC
Scan object - distance:	0.2 ... 3 mm; recommended: 1.0 ± 0.5 mm; Tooth wheel: Module $\geq m1$ to $m3$; tooth face width > 7 mm (spur gear DIN867)
Degree of protection:	Housing: IP66/IP68 Connection Type X IP67; Type XG/XP IP68
Material:	Sensor tube: Stainless steel
Length:	See drawing
Mounting:	Flange mounting
Output channels:	2 channels
Output signal:	2 x square wave signals, level approx. UB
Output stage:	Push-pull amplifier
Galvanic separation:	No



Speed Sensor FAHZ5



Application range

Speed sensors of the FAHZ5 series are especially designed for use in: Transport technology. They measure (non-contacting) the speed of ferromagnetic toothed wheels. Furthermore they can be used to measure any movement of ferromagnetic parts, e. g.:

- Toothed wheels with different tooth forms
- Bolt heads
- Lands detects holes, openings or grooves
- Impuls bands for plain shafts

Measurement principle

Speed sensors of the FAHZ5 series operate according to the difference-hall-effect principle.

Two closely spaced Hall elements are located on the sensor chip. The field of the magnet generates a constant voltage in the Hall elements. Ferromagnetic objects with an interrupted surface moving past the Hall elements cause the Hall voltage to change. When the moving part covers a Hall element and the other does not, a differential voltage is generated to provide a measuring signal. The frequency of this signal is proportional to the speed of movement (rotational speed). The difference-hall-effect principle is direction sensitive.

Specific features

- Robust and high quality housing: IP68 pressure-tight and individually tested at 5 bar
- Speed sensor with two square wave signals, signals 90° offset
- Excellent vibration and shock resistance
- High degree of EMC immunity for difficult electrical environment
- Connection outlet straight or lateral
- Detection of very low speed (near zero speed)
- Due to its design especially suitable for transport technology

Dimensions, connections and drawings

Unless specified differently all dimensions in the following drawings in [mm].

Dimensions and mounting drawing

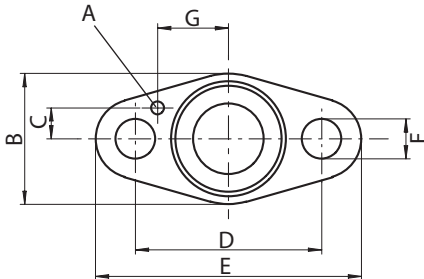

Fig.: FAHZ5_Front View_Dimensions

Explanation to the left illustration

- A) Position pin 3 mm (installing position) acc. DIN1481-3, borehole diameter \varnothing approx. 3.5 mm
- B) Length 29.5 mm
- C) Length 7 mm
- D) Length 42 mm
- E) Length 60 mm
- F) Diameter $\varnothing 9^{0.5}$ mm
- G) Length 16 mm

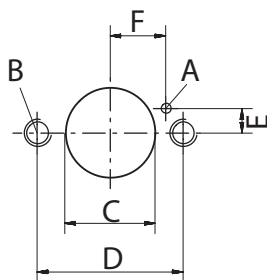

Fig.: Borehole for FAHZ5_Top view

Explanation to the left illustration

- A) Borehole depth for position pin 3 mm (installing position) acc. DIN1481-3, borehole diameter \varnothing approx. 3.5 mm
- B) Borehole size M8-15
- C) Diameter $\varnothing 26^{H10}$
- D) Length $42^{\pm 0.2}$ mm
- E) Length 7 mm
- F) Length 16 mm

Recommended fixing: Hexagon socket screw DIN912 M8x20 with spring ring, \varnothing approx. 3.5 mm



Abb.: FAHZ5_Straight connection outlet

Explanation to the left illustration

- A) Flange: Chromalized aluminium (conductive)
- B) O-Ring seal 21 x 2.5 mm
- C) Sensor tube: Stainless steel
- D) Length 53...78 mm (depending from connection)
- L1) Nominal Length L1 see type code
- E) Length 10 mm
- F) Length 7 mm
- G) Length 3 mm
- H) Diameter 26^{d10} mm
- I) Diameter 16 mm

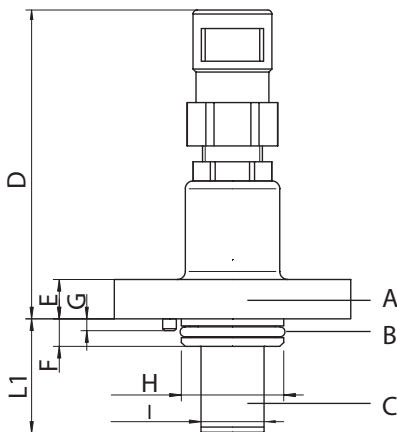
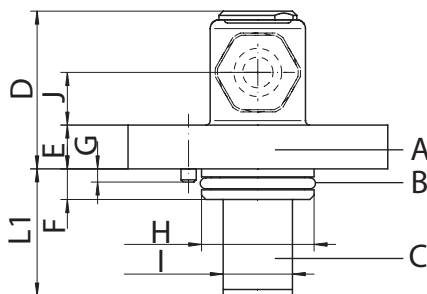

Fig.: FAHZ5_90° connection outlet

Explanation to the left illustration

- A) Flange: Chromalized aluminium (conductive)
- B) O-Ring seal 21 x 2.5 mm
- C) Sensor tube: Stainless steel
- D) Length $37^{\pm 1}$ mm
- L1) Nominal Length L1 see type code
- E) Length 10 mm
- F) Length 7 mm
- G) Length 3 mm
- H) Diameter 26^{d10} mm
- I) Diameter 16 mm
- J) Length 12 mm

Electrical connection

Electrical connection, standard -X, see type code

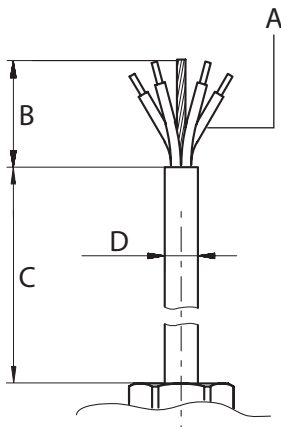

Fig.: Cable type standard FAHZ5...-X

Explanation to the left illustration

- A) Wires 4 x 0.33 mm² halogen-free
- B) Length 80 ±¹⁰ mm
- C) Length K1 ± 5% (K1 see customer drawing)
- D) Diameter 7 ±^{0.5} mm

Electrical connection -XG[..] (textile protection tube), see type code

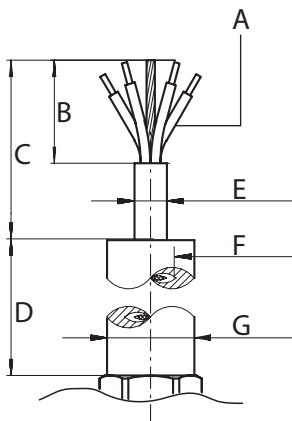

Fig.: Cable type standard FAHZ5...-XG[..]

Explanation to the left illustration

- A) Wires 4 x 0.33 mm² halogen-free
- B) Length 80 ±¹⁰ mm
- C) Length 200 mm
- D) Length K1 ± 5% (K1 see customer drawing)
- E) Diameter 7 ±^{0.5} mm
- F) Inner diameter 7.9 ±^{0.5} mm
- G) Outer diameter 15 ±^{0.5} mm

Electrical connection -XP[..] (polyamid protection tube), see type code

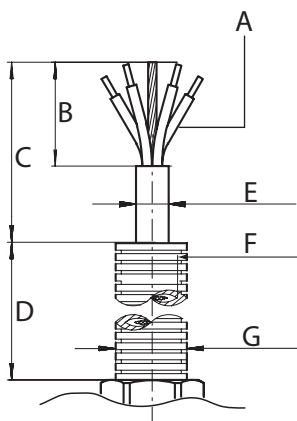

Fig.: Cable type polyamid protection tube FAHZ5...-XP[..]

Explanation to the left illustration

- A) Wires 4 x 0.33 mm² halogen-free
- B) Length 80 ±¹⁰ mm
- C) Length 200 mm
- D) Length K1 ± 5% (K1 see customer drawing)
- E) Diameter 7 ±^{0.5} mm
- F) Inner diameter 9.6 ±^{0.5} mm
- G) Outer diameter 13 ±^{0.5} mm

Connection assignment

Colour	Explanation
Brown	+ U _B
Green	- U _B (0V)
White	Signal Q1
Yellow	Signal Q2
Shielding	Ground

Mounting position and scan object distance

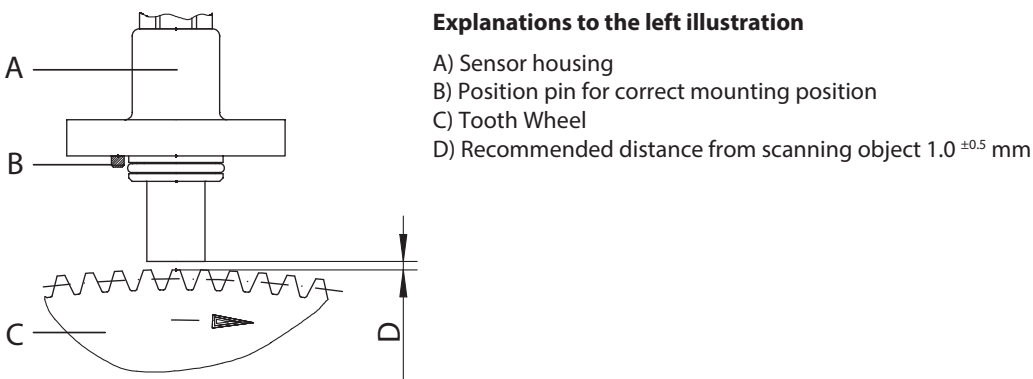
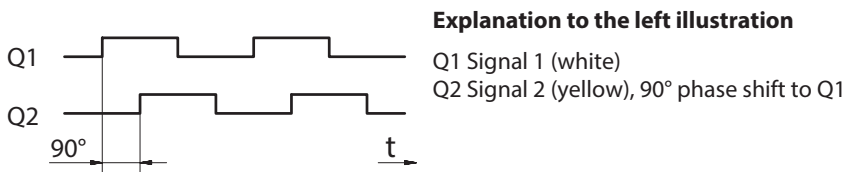

Elementary circuit diagram

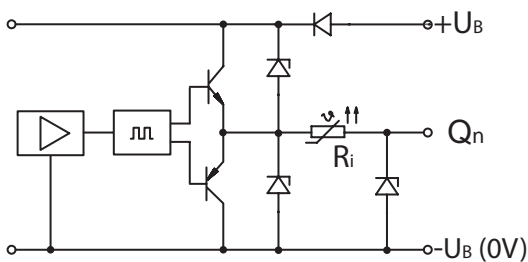

Push-pull output stage

Note:
 NPN- and PNP-inputs can be connected.

Technical data

Electrical connection	
Supply voltage U_s	9 ... 32 VDC
Nominal voltage U_{NOM}	15 VDC
Current consumption I_s	< 20 mA (without output current PNP)
Reverse voltage protection	Yes
Over voltage protection	Yes
Connection	Cable end, customized connections acc. customer drawing
Recommended cable length	< 100 m
Used cable cross section	0,33 mm ² , shielded

Electrical output	
Output channels	2 channels
Output signal	2 x square wave signals, level approx. UB
Output stage	Push-pull amplifier
Continuous short circuit prot.	Yes
Galvanic separation	No
Output level U _{Low}	≤ 0.8 V @ 24 VDC, 10 mA, 24 °C
Output level U _{High}	≥ UB-1.5 V @ 24 VDC, 10 mA, 24 °C
Output current (Sink) I_L	max. -50 mA
Output PNP (Load) I_L	max. 50 mA
Rise time	≥ 10 V/μs
Internal resistance	50 Ω

Signal acquisition	
Measuring principle	Difference-hall-effect principle
Scan type	Non-contacting
Scan object - material	Ferromagnetic materials Tooth wheel: Module ≥ m1 to m3; tooth face width > 7 mm (spur gear DIN867) Hole: Ø ≥ 5 mm, web ≥ 2 mm, depth ≥ 4 mm Groove: Ø ≥ 4 mm, web ≥ 2 mm, depth ≥ 4 mm
Scan object - distance	0.2 ... 3 mm; recommended: 1.0 ± 0.5 mm
Frequency range	0.2 ... 20,000 Hz
Phase-shift	90° ± 10% @ m1.5...m3 90° ± 15% @ m1...m1.25

Environmental influences

Operating temperature T _o	-40 ... +120 °C
Storage temperature T _s	Recommended: -25 ... +70 °C; max.: -40 ... 105 °C (max. limit values within 30 days per year @ relative humidity 5...95%)
Degree of protection	Housing: IP66/IP68 Connection Type X IP67; Type XG/XP IP68
Vibration resistance	DIN IEC 60068-T2-6, 10 g @ 5...2000 Hz (Sinus) DIN EN 61373, 30 g @ 20...500 Hz (Random)
Shock resistance	DIN IEC 60068-T2-27, 1000 m/s ² @ 6 ms
Climatic test	DIN IEC 60068-T2-1/-2/-30
EMI - ESD	IEC 61000-4-2, Lev. 3
EMI - Burst	IEC 61000-4-4, Lev. 3
EMI - Surge	IEC 61000-4-5, Lev. 2
EMI - HF immunity	IEC 61000-4-3, 10 V/m IEC 61000-4-6 (HF - line-bound), 10 Veff IEC 60553 (NF - line-bound), 10 Veff
EMI - emission	CISPR 16-1, CISPR 16-2 EMC2
Insulation voltage	500 VAC, 50 Hz @ 1 min
Further standards	DIN EN 50155, DIN EN 45545

Mech. Quantities

Material	Adapter: Chromalised aluminium Sensor tube: Stainless steel
Mounting	Flange mounting
Length	See drawing
Installation position	Preset with direction of rotation definition, with position pin defined
Installation mode	Direction-sensitive
Weight	100 ... 300 g (depending from connection and length)
Pressure resistance	5 bar (measuring tip)

Other

Approvals	CE
-----------	----

Approvals

The specified approvals are only valid for the technical data of standard products described in this document. In case of customized-products technical deviations are possible. In this case the validity of the according approvals is to be verified.

Type code FAHZ5

Type code structure							
FAHZ5-	11-	S	X	07	-M10	S	Example: FAHZ5-11-SX07-M10S
	Nominal length L1 of the sensor tube						
	Connection outlet						
	Electrical connection						
	Cable length						
	Module						
	Shielding						

Type code FAHZ5...							
Nominal length	11-	L1 = 29 mm					✳
Connection outlet		Without code means: straight outlet					✳
	S	Lateral outlet					
Electrical connection	X	Cable end standard (without protection tubing)					✳
	XG	Cable end with textile protective tubing					
	XP	Cable end with polyamide protective tubing					
Cable sheath length	05	Sheath length 2.0 m, halogen-free					
	07	Sheath length 5.0 m, halogen-free					✳
	08	Sheath length 7.5 m, halogen-free					
	09	Sheath length 10.0 m, halogen-free					
Module	-M10	Module M1					
	-M12	Module M1.25					
	-M15	Module M1.5					
		Without code means module M2					✳
	-M25	Module M2.5					
	-M30	Module M3					
Shielding		Without code: Shielding is attached to the sensor housing					✳
	S	Shielding is not attached to the sensor housing					
FAHZ5 -	-	-	-	-	-	-	Example: FAHZ5-11-X07 (preferred type)

Preferred types

Features marked with a ✳ symbol at the end of the line (see previous table) are preferred features. If you select a preferred feature for each placeholder, the device is specified as preferred type. Preferred types are available quickly from stock. Other types will be delivered according to scheduled appointments.

Special types

If our standard types do not correspond with your expectation, we are pleased to develop a special solution together with you.