

ZEPTO D6

INSTALLATION INSTRUCTIONS

COPYRIGHT

Electrex is a trademark of Akse S.r.l. All rights reserved.
It is forbidden to duplicate, adapt, transcript this document without Akse written authorization, except when regulated accordingly by the Copyright Laws.

WARRANTY

This product is covered by a warranty against material and manufacturing defects for a period of 24 months period from the manufacturing date.

The warranty does not cover the defects that are due to:

- Negligent and improper use
- Failures caused by atmospheric hazards
- Acts of vandalism
- Wear out of materials
- Firmware upgrades

Akse reserves the right, at its discretion, to repair or substitute the faulty products

The warranty is not applicable to the products that will result defective in consequence of a negligent and improper use or an operating procedure not contemplated in this manual.

RETURN AND REPAIR FORMALITIES

Akse accepts the return of instruments for repair only when authorized in advance. The transport costs are at customer charge.

RE-SHIPING OF REPAIRED PRODUCT

The terms for re-shipment of repaired products are ex-works, i.e. the transport costs are at customer charge.

Products returned as defective but found to be perfectly working by our laboratories, will be charged a flat fee to account for checking and testing time irrespective of the warranty terms.

SAFETY

This instrument was manufactured and tested in compliance with CEI EN 61010-1 CAT III-300V, class 2 standards, for operating voltages up to 300 VAC rms phase to neutral.

In order to maintain this condition and to ensure safe operation, the user must comply with the indications and markings contained in the following instructions:

- When the instrument is received, before starting its installation, check that it is intact and no damage occurred during transport.
- Before mounting, ensure that the instrument operating voltages and the mains voltage are compatible then proceed with the installation.
- The instrument power supply needs no earth connection.
- The instrument is not equipped with a power supply fuse; a suitable external protection fuse must be foreseen by the contractor.
- Maintenance and/or repair must be carried out only by qualified, authorized personnel
- If there is ever the suspicion that safe operation is no longer possible, the instrument must be taken out of service and precautions taken against its accidental use.
- Operation is no longer safe when:

- 1) There is clearly visible damage.
- 2) The instrument no longer functions.
- 3) After lengthy storage in unfavorable conditions.
- 4) After serious damage occurred during transport

The instruments must be installed in respect of all the local regulations.

OPERATOR SAFETY

Warning: Failure to observe the following instructions may lead to a serious danger of death.

- During normal operation dangerous voltages can occur on instrument terminals and on voltage and current transformers. Energized voltage and current transformers may generate lethal voltages. Follow carefully the standard safety precautions while carrying out any installation or service operation.
- The terminals of the instrument must not be accessible by the user after the installation. The user should only be allowed to access the instrument front panel where the display is located.
- Do not use the digital outputs for protection functions nor for power limitation functions. The instrument is suitable only for secondary protection functions.
- The instrument must be protected by a breaking device capable of interrupting both the power supply and the measurement terminals. It must be easily reachable by the operator and well identified as instrument cut-off device.
- The instrument and its connections must be carefully protected against short-circuit.

Precautions: Failure to respect the following instructions may irreversibly damage to the instrument.

- The instrument is equipped with PTC current limiting device but a suitable external protection fuse should be foreseen by the contractor.
- The outputs and the options operate at low voltage level; they cannot be powered by any unspecified external voltage.
- The application of currents not compatible with the current inputs levels will damage to the instrument.

Further documentation may be downloaded from our web site www.electrex.it.

This document is owned by company AKSE that reserves all rights.

DECLARATION OF CONFORMITY

Akse hereby declares that its range of products complies with the following directives EMC 89/336/EEC 73/23CE 93/68 CE and complies with the following product's standard CEI EN 61326 – IEC 61326 CEI EN 61010 – IEC 1010.

The product has been tested in the typical wiring configuration and with peripherals conforming to the EMC directive and the LV directive.

Subject to modification without notice. Edition 14-01-2011

READINGS AND DISPLAY

Hold for 2 seconds the button "meas" to display:

- Device name and firmware version
- Serial number
- Rs485 address

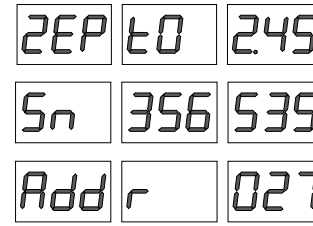

READINGS DISPLAYED

(The parameters available vary according to instrument configuration)

	meas	Σ, ΣPF, F	U	f	I	P	Q	S	PF
Press to scroll readings	page	L-N, ΣPF, F	L-N	f	I	P	Q	S	PF
		THD L-N, ΣPF, F	L-L		In	P Avg	Q L Avg	S Avg	
		L-L, ΣPF, F	THD L-N		THD	P MD	Q C Avg	S MD	
		THD L-L, ΣPF, F	THD L-L		I Avg		Q L MD		
		I, ΣPF, F			I MD		Q C MD		
		THD I, ΣPF, F							
		P, ΣPF, F							
		Q, ΣPF, F							
		S, ΣPF, F							

READINGS DISPLAYED

(The parameters available vary according to instrument configuration)

	cnt	Premere per cambiare misura			
Press for 2 seconds		Ea Σ	Er L Σ	Er C Σ	Es Σ
		Ea Σ €2	Er L Σ €2	Er C Σ €2	Es Σ €2
		TIME Σ	TIME €2		

LEGEND OF PARAMETERS AND SYMBOLS

L-N	Phase Neutral	U	Voltage
L-L	Phase Phase	I	Current
THD	Total Harmonic Distortion	In	Neutral current
Avg	Average (rolling) value	P	Active Power
MD	Maximum Demand	Q	Reactive Power
L	Inductive	S	Apparent Power
C	Capacitive	PF	Power Factor
TIME Σ	Life Time (total) (hour/100)	Ea	Active Energy
TIME €2	Life Time (partial) (hour/100)	Er	Reactive Energy
		Es	Apparent Energy
		f	Frequency

MECHANICAL CHARACTERISTICS

Enclosure	Self-extinguishing plastic material class V0
Protection degree	IP40 on front panel, IP20 terminals side
Dimensions	105 x 90 x 58 mm (6 DIN modules)

VOLTAGE INPUT

Direct	Up to 300 Vrms phase-neutral or 519 Vrms phase to phase
With external PT(VT)	Primary: programmable (max. 400 kV) Secondary: programmable (max. 300 V)
	Overload: 900 Vrms phase to phase for 1 sec
Power supply	230/240Vac +/- 10% 50/60Hz
Self consumption	< 3VA

MODELS

PFA8611-02	ZEPTO D6 RS485 230-240V ENERGY ANALYSER
PFA8611-12	ZEPTO D6 RS485 230-240V 1DI 2DO ENERGY ANALYSER

CONFIGURATION AND SETUP

OPERATING KEYS

Click	Change selected field value	Change selected field value	Go to next field
Click 2 sec	Go to next window	Back to initial entry field	Exits setup

ENTER THE SET UP MODE
Hold the buttons "meas" and "cnt" for 2 seconds to enter in the set up modality.



QUIT THE SET UP MODE
Hold the button "cnt" for 2 seconds to quit the set up modality.



CONFIGURATION PAGES LIST

Once you are in the set up modality the password is asked. The standard password is 0000, to confirm it click 4 times the "cnt" button, otherwise is necessary insert the new password (if previously changed).

PAGE	ITEM DISPLAYED	AVAILABLE PARAMETERS	DEFAULT
PASSWORD PROTECTION		0000 ... 9999	0000

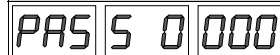

If the instrument is a part of a RS485 network is necessary set up its RS485 address and correct baudrate. If is a "stand alone" instrument you can skip the RS485 set up pressing twice for 2 seconds the button "meas".

RS485

Indirizzo 485	1 ... 247	27
Velocità	2400, 4800, 9600, 19200, 38400	38400
Bit Dati	7 o 8	8
Parità	N = no parity, E = parità pari, O = parità dispari	N
Bit di stop	1 o 2	2

The parameters that must be entered for correct readings in a LT electric grids are: kind of electric grid (net) (see note n°1), CT Primary (Pri) and Secondary (Sec). For HV electric grid is necessary set up also the VT settings.

ELECTRIC GRID PARAMETERS (see note n° 1)

Type	3PH-3W-2CT, 3PH-4W, 2PH-2W, 1PH-2W, 3PH-4Wb	3PH-4W
Primary TA	10000	5
Secondary TA	1 o 5	5
Primary TV	400000	1
Secondary TV	300	1

At this point the initial configuration of the instrument has finished and it is enough to push the "cnt" button for 2 seconds to exit the configuration menu. Otherwise you can go ahead pushing the "meas" button.

DISPLAY BRIGHTNESS

DISPLAY BRIGHTNESS	from 1 to 16	9

TOTAL COUNTERS RESET

TOTAL COUNTERS RESET	NO, YES	NO

PARTIAL COUNTERS RESET

PARTIAL COUNTERS RESET	NO, YES	NO

MAXIMUM DEMAND RESET

MAXIMUM DEMAND RESET	NO, YES	NO

FACTORY DEFAULT RESTORE

FACTORY DEFAULT RESTORE	NO, YES	NO

INSERT NEW PASSWORD

INSERT NEW PASSWORD	0000 ... 9999	0000

Note n° 1

Description	Display visualization
3W Delta (3 wire) 3PH-3W-2CT	
4W Star (4 wire) 3PH-4W	
BI-PHASE 2PH-2W	
SINGLE PHASE 1PH-2W	
4W STAR BALANCED (4 FILI) 3PH-4Wb	

"Err" MESSAGE

During the set up it could happen that the "err" message will show up in the display. This only means that some not accepted parameters are saved in the configuration. The factory default parameters needs to be restored with the following procedure:



The following of this procedure will configure the instrument as by factory default. After a factory default restore the stored data won't be lost, just the configuration will be restored.

DIGITAL INPUTS AND OUTPUTS CONNECTION

(Applicable only to type PFA8611-12)

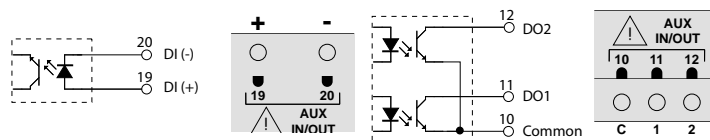

Digital Inputs	
Supply voltage (external):	from 10 to 30 Vdc
Current consumption:	from 2 to 10mA
Max. count frequency	10 or 100Hz

N.B. For gas meters a galvanic separation is needed per ATEX standards

Digital outputs (optocoupled NPN transistor type per DIN 43864)	
Maximum applicable voltage:	27 Vdc
Maximum switchable current:	27 mA

DIGITAL INPUT AND OUTPUTS WIRING EXAMPLE

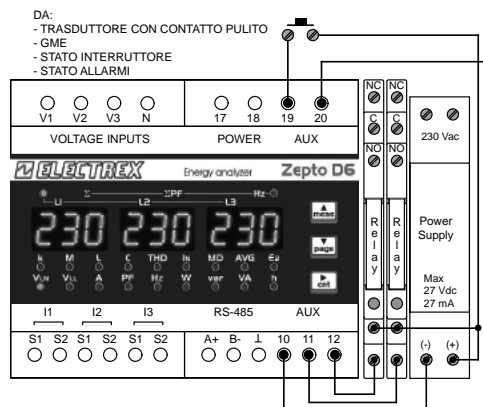
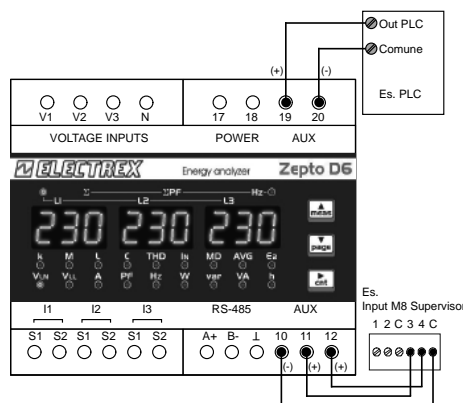

VOLTAGE AND CURRENT CONNECTIONS

Voltage connection

Use cables with max cross-section of 2,5 mm² if flexible 4 mm² if rigid and connect them to the terminals marked voltage input on the instrument according to the applicable diagrams that follow.

Current connection

It is necessary to use external CTs with a primary rating adequate to the load to be metered and with a 5A or 1A secondary rating. The number of CTs to be used (1, 2 or 3) depends upon the type of network. Connect the CT output(s) to the terminals marked I1, I2, I3 (current input) of the instrument according to the applicable diagrams that follow. Use cables with cross-section adequate to the VA rating of the CT and to the distance to be covered. The max cross-section for the terminals is 4 mm².

N.B. The CT secondary must always be in short circuit when not connected to the instrument in order to avoid damages and risks for the operator.

Warning: The phase relationship among voltage and current signals, the P1-P2 orientation and the S1-S2 connection of the CT(s) must be carefully respected.

All disregard of this rule or of the wiring diagram leads to severe measurement errors.

4W Star (4 wire) 3PH-4W

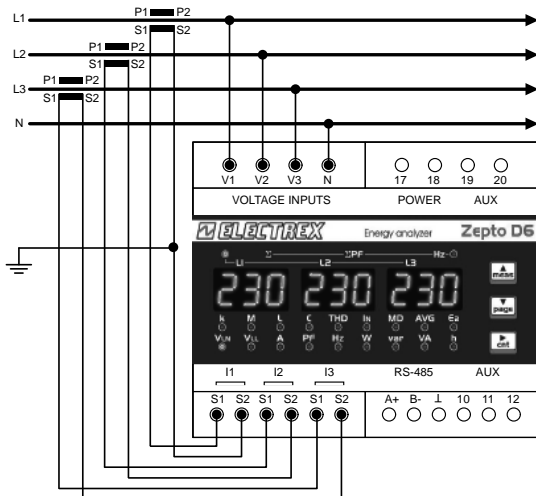

SINGLE PHASE 1PH-2W

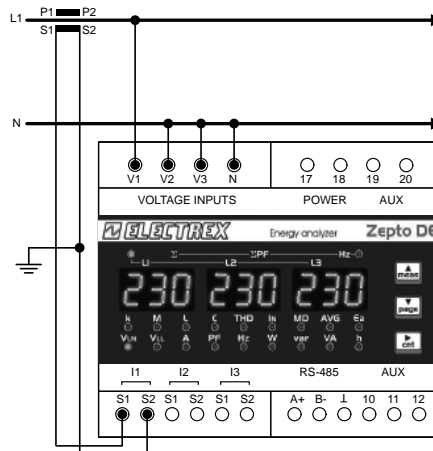

3W Delta (3 wire) 3PH-3W-2CT

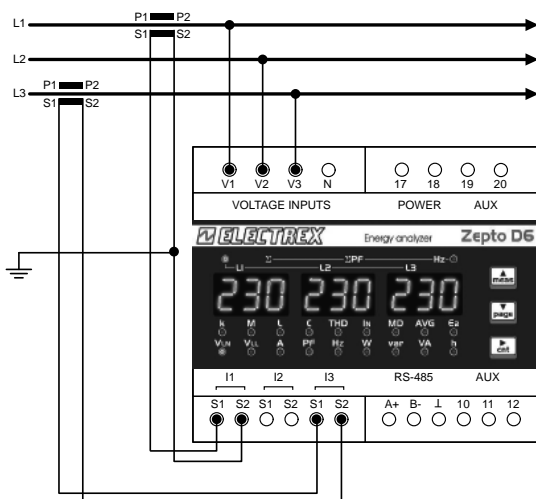

BI-PHASE 2PH-2W

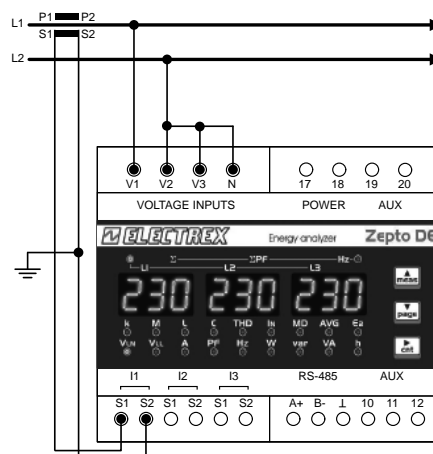

BALANCED STAR 4W (4 WIRES) 3PH-4W BAL

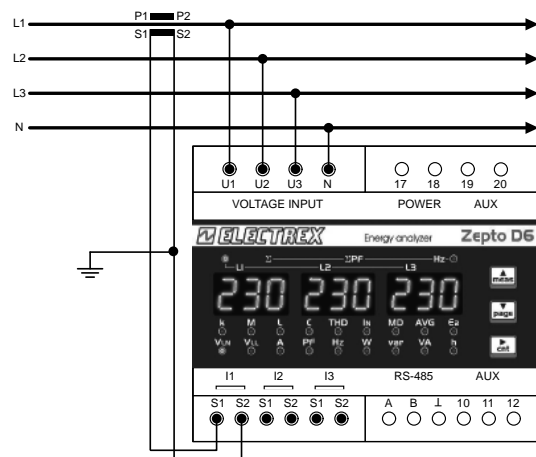

POWER SUPPLY and SERIAL LINE CONNECTION

The instrument is fitted with a separate power supply. The power supply terminals are numbered (17) and (18). Use cables with max cross-section of 2,5 mm² if flexible, 4 mm² if rigid.

