

X3M, X3M-H, Flash N, Flash N-H Installation Manual

This instructions manual is common to both the instruments type X3M-D and Flash-D.

COPYRIGHT

Akse S.r.l. All rights are reserved.
It is forbidden to duplicate, adapt, transcript this document without Akse written authorization, except when regulated accordingly by the Copyright Laws.
Copyright© 2003-2004

WARRANTY

This product is covered by a warranty against material and manufacturing defects for a period of 36 months period from the manufacturing date
The warranty does not cover the defects that are due to:

- Negligent and improper use
- Failures caused by atmospheric hazards
- Acts of vandalism
- Wear out of materials

Akse reserves the right, at its discretion, to repair or substitute the faulty products

The warranty is not applicable to the products that will result defective in consequence of a negligent and improper use or an operating procedure not contemplated in this manual.

RETURN AND REPAIR FORMALITIES

Akse accepts the return of instruments for repair **only** when authorized in advance. For instrument purchased directly, the repair authorization must be requested to Electrex directly by using the enclosed RMA form.

RE-SHIPING OF REPAIRED PRODUCT

The terms for re-shipment of repaired products are ex-works, i.e. the transport costs are at customer charge.

Products returned as defective but found to be perfectly working by our laboratories, will be charged a fixed fee (40.00 Euro + VAT where applicable) to account for checking and testing time irrespective of the warranty terms.

Safety

This instrument was manufactured and tested in compliance with IEC 61010 class 2 standards for operating voltages up to 250 VAC rms phase to neutral.

In order to maintain this condition and to ensure safe operation, the user must comply with the indications and markings contained in the following instructions:

- When the instrument is received, before starting its installation, check that it is intact and no damage occurred during transport.
- Before mounting, ensure that the instrument operating voltages and the mains voltage are compatible then proceed with the installation.
- The instrument power supply needs no earth connection.
- The instrument is not equipped with a power supply fuse; a suitable external protection fuse must be foreseen by the contractor.
- Maintenance and/or repair must be carried out only by qualified, authorized personnel
- If there is ever the suspicion that safe operation is no longer possible, the instrument must be taken out of service and precautions taken against its accidental use.
- Operation is no longer safe when:
 - 1) There is clearly visible damage.
 - 2) The instrument no longer functions.
 - 3) After lengthy storage in unfavorable conditions.
 - 4) After serious damage occurred during transport

The instruments X3M and Flash-N must be installed in respect of all the local regulations.

Operator safety

Warning: Failure to observe the following instructions may lead to a serious danger of death.

- During normal operation dangerous voltages can occur on instrument terminals and on voltage and current transformers. Energized voltage and current transformers may generate lethal voltages. Follow carefully the standard safety precautions while carrying out any installation or service operation.
- The terminals of the instrument **must** not be accessible by the user after the installation. The user should only be allowed to access the instrument front panel where the display is located.
- Do not use the digital outputs for protection functions nor for power limitation functions. The instrument is suitable only for secondary protection functions.
- The instrument must be protected by a breaking device capable of interrupting both the power supply and the measurement terminals. It must be easily reachable by the operator and well identified as instrument cut-off device.
- The instrument and its connections must be carefully protected against short-circuit.

Precautions: Failure to respect the following instructions may irreversibly damage to the instrument.

- The instrument is equipped with PTC current limiting device but a suitable external protection fuse should be foreseen by the contractor.
- The outputs and the options operate at low voltage level; they cannot be powered by any unspecified external voltage.
- The application of currents not compatible with the current inputs levels will damage to the instrument.

Mounting

Instruments size (mm)

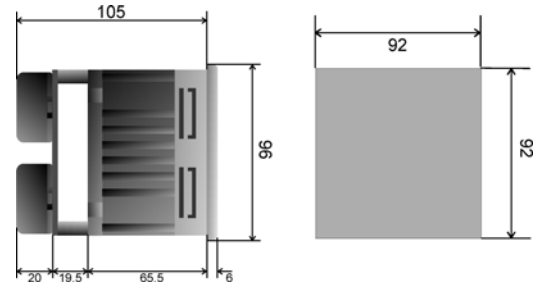

Fixing and blocking

The instrument (as well as the optional modules) are fixed to the DIN rail by means of the spring clip located on the rear side of the unit

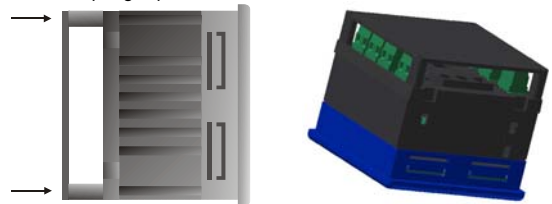

Wiring diagrams

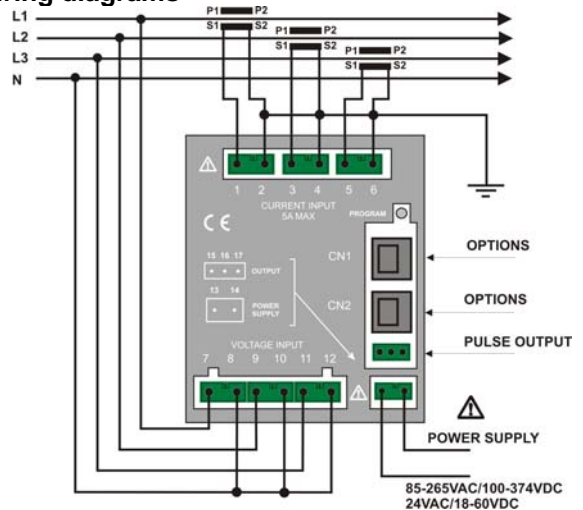

Power supply

The instrument is fitted with a separate power supply with extended operating range. The power supply terminals are numbered (10) and (11). Use cables with max cross-section of 4 mm².

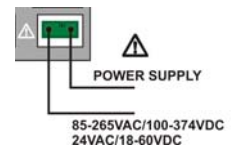

Voltage connection

Connessioni voltmetriche

Use cables with max cross-section of 4 mm² and connect them to the terminals marked VOLTAGE INPUT on the instrument according to the applicable diagrams that follow.

Current connection

It is necessary to use external CTs with a primary rating adequate to the load to be metered and with a 5A secondary rating. The number of CTs to be used (1, 2 or 3) depends upon the type of network.

Connect the CT output(s) to the terminals marked CURRENT INPUT of the instrument according to the applicable diagrams that follow.

Use cables with cross-section adequate to the VA rating of the CT and to the distance to be covered. The max cross-section for the terminals is 4 mm².

N.B. The CT secondary must always be in short circuit when not connected to the instrument in order to avoid damages and risks for the operator.

Warning: THE PHASE RELATIONSHIP AMONG VOLTAGE AND CURRENT SIGNALS MUST BE CAREFULLY RESPECTED. ALL DISREGARD OF THIS RULE OR OF THE WIRING DIAGRAM LEADS TO SEVERE MEASUREMENT ERRORS.

4W Star connection (4 wire)

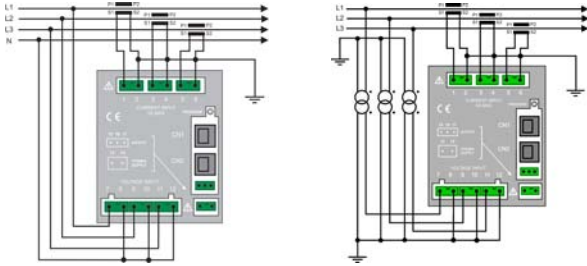

Low voltage 3 CTs
Configuration 3Ph/4W

High voltage 3 PTs 3 CTs
Configuration 3Ph/4W

3W Delta connection (3 wire) Connection with 3 CTs

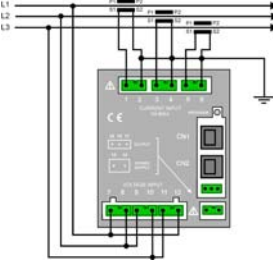

Connection with 1 CT

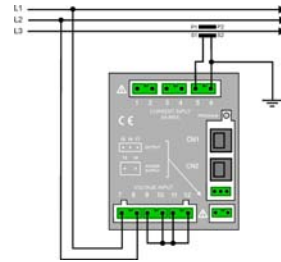

Low Voltage 3 CTs (unbalanced load)

Configuration 3Ph/3W

Low Voltage 1 CT (symmetrical and balanced load)

Configuration 3Ph/3W-Bal

Connection with 2 CTs on L1 and L3

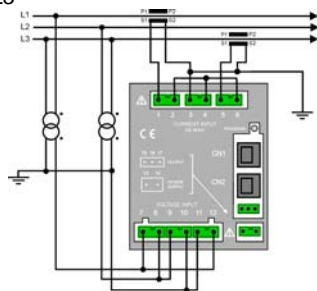
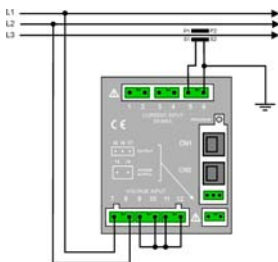

Low Voltage 3 CTs (unbalanced load)

Configuration 3Ph/3W

Low Voltage 1 CT (symmetrical and balanced load)

Configuration 3Ph/3W-Bal

Outputs connection

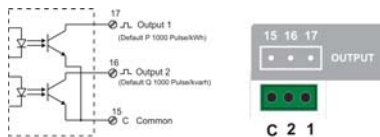

Instrument set up

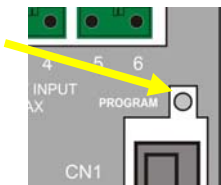

The set up procedure allows to program the instrument operating parameters. Entry in the programming procedure is obtained by pressing the PROGRAM button that is located on the upper right side of the instrument.

The **▶** key allows to scroll the various entry fields within a set up page as well as to pass to the next page upon scrolling all the fields of one page. The **▼** and **▲** keys allow the modification of the flashing field being currently selected.

The content of a field can be either numeric or a parameter controlling the device behavior. The **⏏** key advances to the next page, the **⏪** key returns to the previous page.

By pressing the PROGRAM button (while in any configuration page) the menu is exited and the configuration entries so far performed are saved.

Configuration procedure

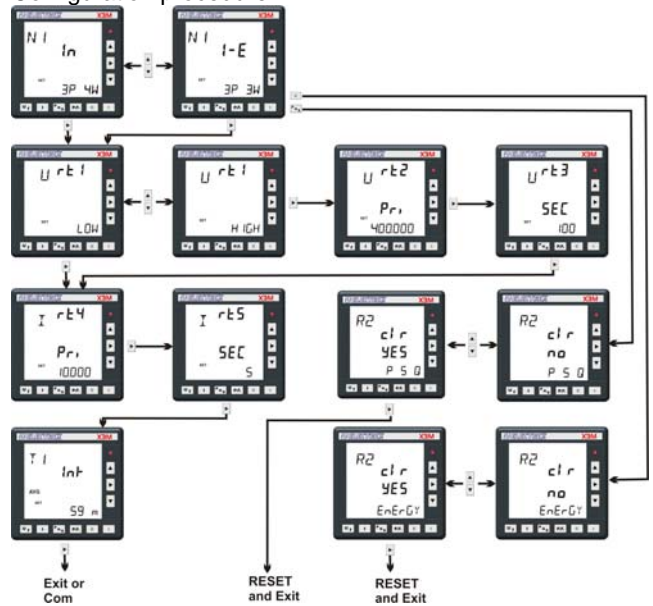

Communication characteristics configuration

This menu appear only upon connection to the instrument of an RS-485 or an RS-232 optional module. The setting of the RS485 communication characteristics requires to scroll the programming pages with two keys; The **⏏** key advances to the next page, the **⏪** key returns to the previous page



The first page enables MODBUS communication protocol to be set: the Slave Address, Transmission delay, RTU or ASC (ASCII) mode. Transmission delay stands for the time delay the instrument will wait prior to reply to a data query. It is expressed in milliseconds, the default value is 100 msec and a 0 setting is also possible.

All these data are correlated depending upon the stop bit value.

Additional parameters regarding the the setting of communication speed, number of data bits, parity, stop bits are available in the next page.



Readings

The selection of the readings and of the reading pages is made by means of the following keys: **⏪** Voltage and frequency key, **⏩** Currents key,

⏏ Powers key, **⏪** Power factor key, **⏩** Energies key, **⏏** Life time,

indicator key, **▲** **▼** Move the selection up and down in the readings pages,

▶ This key is not used in the readings pages, it displays instruments information (loader version, application version, serial number, available options).

A broader instructions manual including the Modbus protocol mapping may be downloaded from our web page www.electrex.it.

DECLARATION OF CONFORMITY

Akse hereby declares that its range of products complies with the following directives **EMC 89/336/EEC 73/23CE 93/68 CE** and complies with the following product's standard **CEI EN 61326 – IEC 61326 CEI EN 61010 – IEC 1010**

The product has been tested in the typical wiring configuration and with peripherals conforming to the EMC directive and the LV directive.

The Technical file report is available at:

Edition 3 January 2007 Subject to modification without notice