

FEMTO 96

INSTALLATION GUIDE

COPYRIGHT

Electrex is a trademark of Akse S.r.l. All rights reserved.
It is forbidden to duplicate, adapt, transcript this document without Akse written authorization, except when regulated accordingly by the Copyright Laws.

WARRANTY

This product is covered by a warranty against material and manufacturing defects for a 24 months period from the manufacturing date.

The warranty does not cover the defects that are due to:

- Negligent and improper use
- Failures caused by atmospheric hazards
- Acts of vandalism
- Wear out of materials
- Firmware upgrades

Akse reserves the right, at its discretion, to repair or substitute the faulty products

The warranty is not applicable to the products that will result defective in consequence of a negligent and improper use or an operating procedure not contemplated in this manual.

RETURN AND REPAIR FORMALITIES

Akse accepts the return of instruments for repair only when authorized in advance. The transport costs are at customer charge.

RE-SHIPING OF REPAIRED PRODUCT

The terms for re-shipment of repaired products are ex-works, i.e. the transport costs are at customer charge.

Products returned as defective but found to be perfectly working by our laboratories, will be charged a flat fee to account for checking and testing time irrespective of the warranty terms.

SAFETY

This instrument was manufactured and tested in compliance with IEC 61010 class 2 standards for operating voltages up to 250 VAC rms phase to neutral.

In order to maintain this condition and to ensure safe operation, the user must comply with the indications and markings contained in the following instructions:

- When the instrument is received, before starting its installation, check that it is intact and no damage occurred during transport.
- Before mounting, ensure that the instrument operating voltages and the mains voltage are compatible then proceed with the installation.
- The instrument power supply needs no earth connection.
- The instrument is not equipped with a power supply fuse; a suitable external protection fuse must be foreseen by the contractor.
- Maintenance and/or repair must be carried out only by qualified, authorized personnel
- If there is ever the suspicion that safe operation is no longer possible, the instrument must be taken out of service and precautions taken against its accidental use.
- Operation is no longer safe when:

- 1) There is clearly visible damage.
- 2) The instrument no longer functions.
- 3) After lengthy storage in unfavorable conditions.
- 4) After serious damage occurred during transport

The instruments must be installed in respect of all the local regulations.

OPERATOR SAFETY

Warning: Failure to observe the following instructions may lead to a serious danger of death.

- During normal operation dangerous voltages can occur on instrument terminals and on voltage and current transformers. Energized voltage and current transformers may generate lethal voltages. Follow carefully the standard safety precautions while carrying out any installation or service operation.
- The terminals of the instrument must not be accessible by the user after the installation. The user should only be allowed to access the instrument front panel where the display is located.
- Do not use the digital outputs for protection functions nor for power limitation functions. The instrument is suitable only for secondary protection functions.
- The instrument must be protected by a breaking device capable of interrupting both the power supply and the measurement terminals. It must be easily reachable by the operator and well identified as instrument cut-off device.
- The instrument and its connections must be carefully protected against short-circuit.

Precautions: Failure to respect the following instructions may irreversibly damage to the instrument.

- The instrument is equipped with PTC current limiting device but a suitable external protection fuse should be foreseen by the contractor.
- The outputs and the options operate at low voltage level; they cannot be powered by any unspecified external voltage.
- The application of currents not compatible with the current inputs levels will damage to the instrument.

Further documentation may be downloaded from our web site www.electrex.it.

This document is owned by company AKSE that reserves all rights.

DECLARATION OF CONFORMITY

Akse hereby declares that its range of products complies with the following directives EMC 89/336/EEC 73/23CE 93/68 CE and complies with the following product's standard CEI EN 61326 – IEC 61326 CEI EN 61010 – IEC 1010.

The product has been tested in the typical wiring configuration and with peripherals conforming to the EMC directive and the LV directive.

Subject to modification without notice. Edition 02-07-2008

READINGS



- Keep pressed for 2 seconds to display:
- Type of instrument
 - Firmware version
 - Serial number
 - RS485 address

READINGS DISPLAYED IN THE UPPER SCREEN AREA (The parameters available vary according to instrument configuration)

meas	Ea	Er	Es	U	U-f	I	P	Q	S	PF
page	Ea Imp	Er Ind Imp	Es Imp	L-N	L-N f	I	P	Q	S	PF
Press to scroll readings	Ea Exp	Er Cap Imp	Es Exp	L-L	L-L f	In	P Avg Imp	Q Avg Imp	S Avg Imp	
	Ea Phase	Er Ind Exp		THD L-N	THD L-N f	THD	P Avg Exp	Q Avg Exp	S Avg Exp	
		Er Cap Exp		THD L-L	THD L-L f	I Max	P MD Imp	Q MD Imp	S MD Imp	
		Er Ind Phase		Min L-N	Min L-N f	I Avg	P MD Exp	Q MD Exp	S MD Exp	
				Min L-L	Min L-L f	I MD				
				Max L-N	Max L-N f					
			Max L-L	Max L-L f						

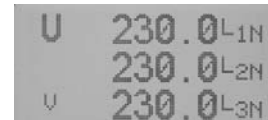

READINGS DISPLAYED IN THE LOWER SCREEN AREA (The parameters available vary according to instrument configuration)

cnt	Press to change readings			
Press for 2 seconds	Ea Σ+	Er L Σ+	Er C Σ+	Es Σ+
	Ea Σ-	Er L Σ-	Er C Σ-	Es Σ-
	Ea P+	Er L P+	Er C P+	Es P+
	Ea P-	Er L P-	Er C P-	Es P-
	CNT1 Σ			
	CNT1 P			
	TIME Σ	TIME P		
	TEMP °C	TEMP °F		



LEGEND OF PARAMETERS AND SYMBOLS

L-N	Phase Neutral	U	Voltage
L-L	Phase Phase	I	Current
THD	Total Harmonic Distortion	In	Neutral current
Avg	Average (rolling) value	P	Active Power
MD	Maximum Demand	Q	Reactive Power
Imp (+)	Import value	S	Apparent Power
Exp (-)	Export value	PF	Power Factor
IND	Inductive	Ea	Active Energy
CAP	Capacitive	Er	Reactive Energy
Min	Minimum values (10 cycles time base)	Es	Apparent Energy
Max	Maximum values (10 cycles time base)	f	Frequency
TIME Σ	Life Time (total)	TEMP °C	Temperature in °Celsius
TIME P	Life Time (partial)	TEMP °F	Temperature in °Fahrenheit
CNT Σ	Pulse count (total)		
CNT P	Pulse count (partial)		

MECHANICAL CHARACTERISTICS

Case	Self-extinguishing plastic material class V0
Protection degree	IP65 on front panel, IP20 terminals side
Size	96 x 96 x 72 mm

CURRENT INPUT

Direct	Up to 300 Vrms phase-neutral or 519 Vrms phase to phase
With external PT(VT)	Primary: programmable (max. 400 kV) Secondary: programmable (max. 300 V)
	Overload: 900 Vrms phase to phase for 1 sec
Power supply	230/240Vac +/- 10% 50/60Hz
Self consumption	< 3VA

MODELS

PFA6C11-02	FEMTO 96 RS485 230-240V ENERGY ANALYSER
PFA6C11-12	FEMTO 96 RS485 230-240V 1DI 2DO ENERGY ANALYSER

DEVICE SETUP

OPERATING KEYS

Click	Change selected field value	Change selected field value	Go to next field
Click 2 sec	Go to next window	Back to initial entry field	Exits setup

ENTERS INTO SET UP MODE
(Push together for 2 seconds)



SETUP SEQUENCE

PAGE	PARAMETERS	VALUES AVAILABLE	DEFAULT
PASSWORD REQUEST			
		0000 ... 9999	0000
RS485			
	RS485 Address	1 ... 247	27
	Rate	2400, 4800, 9600, 19200, 38400	38400
	Data Bit	7 or 8	8
	Parity	N = no parity, E = even parity, O = odd parity	N
	Stop Bit	1 or 2	2
<div style="border: 1px solid black; padding: 5px; width: fit-content; margin: 0 auto;"> RS-485 ADDR 027 COM 38400-8-N-2 </div>			

NETWORK			
	Type (note n.1)	3PH-3W-2CT, 3PH-4W, 2PH-2W, 1PH-2W	3PH-4W
	Export	NO, YES	NO
	CT	10000/1 or 5	5/5
	VT	400000/300	1/1

NETWORK	
TYPE	3PH-4W
EXPORT	NO
CT	00005/5
VT	000001/001

AVG-MD TIME (note n.2)			
	POWERS	1...60 (minutes)	15
	CURRENTS	1...60 (minutes)	8

AVG-MD TIME	
POWERS	15
CURRENTS	08

ALARM 1 / A (note n.11)			
	MODE (note n.3)	Normal, 1-OF-3, 3-OF-3, DERIV, UNBAL	NORMAL
	TYPE (note n.4)	MAX, MIN	MIN
	MEAS (note n.5)	Controlled measure. See table n.1 for register selection	200
	THRE (note n.5)	Threshold value	0

ALARM 1/A	
MODE	NORMAL
TYPE	MIN
MEAS	200
THRE	000,00

ALARM 1 / B			
	HYST	1...100 (%)	1
	DELAY	1...99 (seconds)	1
	AVG (note n.6)	1...99 (seconds)	1
	OUT (note n.7)	Normal, Hold, Pulse-L, Pulse-S	NORMAL

ALARM 1/B	
HYST	01
DELAY	01
AVG	01
OUT	NORMAL

ALARM 2 / A (note n.11)			
	MODE (note n.3)	Normal, 1-OF-3, 3-OF-3, DERIV, UNBAL	NORMAL
	TYPE (note n.4)	MAX, MIN	MIN
	MEAS (note n.5)	Controlled measure. See table n.1 for register selection	200
	THRE (note n.5)	Threshold value	0

ALARM 2 / B			
	HYST	1...100 (%)	1
	DELAY	1...99 (seconds)	1
	AVG (note n.6)	1...99 (seconds)	1
	OUT (note n.7)	Normal, Hold, Pulse-L, Pulse-S	NORMAL

ALARM 3 / A (note n.11)			
	MODE (note n.3)	Normal, 1-OF-3, 3-OF-3, DERIV, UNBAL	NORMAL
	TYPE (note n.4)	MAX, MIN	MIN
	MEAS (note n.5)	Controlled measure. See table n.1 for register selection	200
	THRE (note n.5)	Threshold value	0

ALARM 3 / B			
	HYST	1...100 (%)	1
	DELAY	1...99 (seconds)	1
	AVG (note n.6)	1...99 (seconds)	1
	OUT (note n.7)	Normal, Hold, Pulse-L, Pulse-S	NORMAL

ALARM 4 / A (note n.11)			
	MODE (note n.3)	Normal, 1-OF-3, 3-OF-3, DERIV, UNBAL	NORMAL
	TYPE (note n.4)	MAX, MIN	MIN
	MEAS (note n.5)	Controlled measure. See table n.1 for register selection	200
	THRE (note n.5)	Threshold value	0

ALARM 4 / B			
	HYST	1...100 (%)	1
	DELAY	1...99 (seconds)	1
	AVG (note n.6)	1...99 (seconds)	1
	OUT (note n.7)	Normal, Hold, Pulse-L, Pulse-S	NORMAL

DIGITAL OUT 1 (note n.8)			
	MODE	PULSE, ALARM, REMOTE	PULSE
	POLARITY	NO, NC	NO

DIGITAL OUT 1			
	MODE	PULSE	
	POLARITY	NO	

PULSE OUT 1			
	MEAS (note n.9)	P-IMP, QL-IMP, QC-IMP, S-IMP, P-EXP, QL-EXP, QC-EXP, S-EXP	P-IMP
	PRIMARY (note n.10)	YES, NO	YES
	WEIGHT	1...100000000 (Wh/100)	100000
	WIDTH	50ms...1S	500

PULSE OUT 1			
	MEAS	P-IMP	
	PRIMARY	YES	
	WEIGHT	100,00k	
	WIDTH	0500	

DIGITAL OUT 2 (note n.8)			
	MODE	PULSE, ALARM, REMOTE	PULSE
	POLARITY	NO, NC	NO

PULSE OUT 2			
	MEAS (note n.9)	P-IMP, QL-IMP, QC-IMP, S-IMP, P-EXP, QL-EXP, QC-EXP, S-EXP	QL-IMP
	PRIMARY (note n.10)	YES, NO	YES
	WEIGHT	1...100000000 (Wh/100)	100000
	WIDTH	50ms...1S	500

CLEAR TOTAL COUNTERS	NO, YES		NO
CLEAR PARTIAL COUNTERS	NO, YES		NO
CLEAR MIN-MAX	NO, YES		NO
CLEAR MAX DEMAND	NO, YES		NO
ENTER NEW PASSWORD	0000 ... 9999		0000

EXIT SETUP
(push for 2 seconds)



TABLE n.1 (ModBus Registers for alarm configuration)

REGISTER	DESCRIPTION	SYMBOL	UNITS
200	Phase to Neutral Voltage, THD	THD U1N	[%]
202	Phase to Neutral Voltage, THD	THD U2N	[%]
204	Phase to Neutral Voltage, THD	THD U3N	[%]
206	Phase to Phase Voltage, THD	THD U12	[%]
208	Phase to Phase Voltage, THD	THD U23	[%]
210	Phase to Phase Voltage, THD	THD U31	[%]
212	Phase Current, THD	THD I1	[%]
214	Phase Current, THD	THD I2	[%]
216	Phase Current, THD	THD I3	[%]
218	Frequency of U1N	f	[Hz]
220	Phase to Neutral Voltage, RMS Amplitude	U1N	[V]
222	Phase to Neutral Voltage, RMS Amplitude	U2N	[V]
224	Phase to Neutral Voltage, RMS Amplitude	U3N	[V]
226	Phase to Phase Voltage, RMS Amplitude	U12	[V]
228	Phase to Phase Voltage, RMS Amplitude	U23	[V]
230	Phase to Phase Voltage, RMS Amplitude	U31	[V]
232	Phase Current, RMS Amplitude	I1	[A]
234	Phase Current, RMS Amplitude	I2	[A]
236	Phase Current, RMS Amplitude	I3	[A]
238	Neutral Current, RMS Amplitude	IN	[A]
240	Phase Active Power (Imp/ Exp)	P1	[W]
242	Phase Active Power (Imp/ Exp)	P2	[W]
244	Phase Active Power (Imp/ Exp)	P3	[W]
246	Phase Reactive Power (Imp/ Exp)	Q1	[var]
248	Phase Reactive Power (Imp/ Exp)	Q2	[var]
250	Phase Reactive Power (Imp/ Exp)	Q3	[var]
252	Phase Apparent Power	S1	[VA]
254	Phase Apparent Power	S2	[VA]
256	Phase Apparent Power	S3	[VA]
258	Phase Power Factor (Imp/ Exp)	PF1	[-]
260	Phase Power Factor (Imp/ Exp)	PF2	[-]
262	Phase Power Factor (Imp/ Exp)	PF3	[-]
264	Phase to Neutral Voltage, Mean THD	THD UI	[%]
266	Phase to Phase Voltage, Mean THD	THD UD	[%]
268	Phase Current, Mean THD	THD I	[%]
270	Phase to Neutral Voltage, Mean RMS Amplitude	UI	[V]
272	Phase to Phase Voltage, Mean RMS Amplitude	UD	[V]
274	Three phase current, RMS Amplitude	I	[A]
276	Total active power (Imp/ Exp)	PS	[W]
278	Total reactive power (Imp/ Exp)	QS	[var]
280	Total apparent power	SS	[VA]
282	Total power factor (Imp/ Exp)	PFS	[-]
332	Phase Current, RMS Amplitude, AVG	I1 AVG	[A]
334	Phase Current, RMS Amplitude, AVG	I2 AVG	[A]
336	Phase Current, RMS Amplitude, AVG	I3 AVG	[A]
344	Total imported active power, AVG	P Imp AVG	[W]
346	Total imported inductive power, AVG	Qind Imp AVG	[var]
348	Total imported capacitive power, AVG	Qcap Imp AVG	[var]
350	Total imported apparent power, AVG	S Imp AVG	[VA]
352	Total exported active power, AVG	P Exp AVG	[W]
354	Total exported inductive power, AVG	Qind Exp AVG	[var]
356	Total exported capacitive power, AVG	Qcap Exp AVG	[var]
358	Total exported apparent power, AVG	S Exp AVG	[VA]
376	External Pulse Counter, With Weight, Total counter or Tariff T1	CNT1 S	
384	External Pulse Counter, With Weight, Partial Counter or Tariff T2	CNT1 P	

Note n.1	
3PH-3W-2CT	2 phases 3 wires, triangle
3PH-4W	3 phases 4 wires, Star
2PH-2W	2 phases 2 wires, biphasic
1PH-2W	1 phase 2 wires, monophase
Note n.2	
POWERS	Integration time of the average value (AVG) and peak value (MD) for power (da 1 a 60 minuti)
CURRENTS	Integration time of the average value (AVG) and peak value (MD) for current (da 1 a 60 minuti)
Note n.3	
Normal	Classic Alarm with reference to a fixed threshold or to maximum and minimum delay and applicable hysteresis. "AVG" parameter is not used.
1-OF-3	Consider also the 2 following registers of the selected one in "MEAS". Works on a fixed max or min threshold with delay and applicable hysteresis. If one of the three register exceed the threshold the alarm goes on. "AVG" parameter is not used.
3-OF-3	Consider also the 2 following registers of the selected one in "MEAS". Works on a fixed max or min threshold with delay and applicable hysteresis. When all the three register exceed the threshold the alarm goes on. "AVG" parameter is not used.
DERIV	"THRE" parameter becomes a % value, "AVG" parameter is used. The instant value applied to the alarm on "MEAS" is compared with its value mediated obtained on the basis of the time set on "AVG". When the instantaneous value combined alarm differs in more (setting "Max") or less (setting "MIN") from the average value ("AVG") of the percentage set on "THRE" the alarm goes on. With delay and applicable hysteresis.
UNBAL	Consider also the 2 following registers of the selected one in "MEAS". "THRE" parameter becomes a % value. Alarm goes on when one of the three register is different from the percentage set on "THRE" comply with the higher value of the three read register if "MAX" is set on "TYPE", or comply with the lower value of the three register if "MIN" is set on "TYPE" With delay and applicable hysteresis.
Note n.4	
MAX	Alarm setting in excess compared with the established conditions. With the exception of "UNBAL".
MIN	Alarm setting in decrease compared with the established conditions. With the exception of "UNBAL".
Note n.5	
MEAS	indicates which register (and thus measure) the alarm is related. See table n.1 input register.
THRE	Alarm threshold in absolute value, with the exception made for "DERIV" and "UNBAL" in which the value inserted becomes a percentage.
Note n.6	
AVG	Parameter to be used only in "DERIV" mode. Is the duration of the reference (in seconds) used to create a reference value for the instantaneous readings.
Note n.7	
NORMAL	Physical output of the alarm excited during the duration of the alarm. It restores automatically
HOLD	Output remains excited until manual reset made via Modbus
PULSE-L	Output generate a 500ms impulse when the alarm goes on.
PULSE-S	Output generate a 100ms impulse when the alarm goes on.
Note n.8	
PULSE	Enables exit function as impulsive
ALARM	Enables exit function as alarm
REMOTE	Enables function output via protocol Modbus
NO	Normally open
NC	Normally closed
Note n.9	
P-IMP	Imported Active Power (Energy)
QL-IMP	Imported Reactive Inductive Power (Energy)
QC-IMP	Imported Reactive Capacitive Power (Energy)
S-IMP	Imported Apparent Power (Energy)
P-EXP	Exported Active Power (Energy)
QL-EXP	Exported Reactive Inductive Power (Energy)
QC-EXP	Exported Reactive Capacitive Power (Energy)
S-EXP	Exported Apparent Power (Energy)
Note n.10	
YES	Referred to CT primary
NO	Referred to CT secondary
Note n.11	
ALLARME 1	Alarm related to the physical output: DIGITAL OUT 1 (DO1, terminal 8)
ALLARME 2	Alarm related to the physical output: DIGITAL OUT 2 (DO2, terminal 9)
ALLARME 3	Only MODBUS alarm
ALLARME 4	Only MODBUS alarm

DIGITAL INPUTS AND OUTPUTS CONNECTION

(only for the version PFA6C11-12)

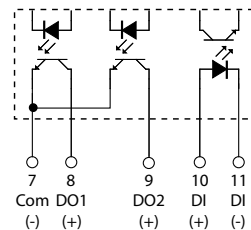

Digital Inputs	
Supply voltage (external):	from 10 to 30 Vdc
Current consumption:	from 2 to 10mA
Max. count frequency	10 or 100Hz
N.B. For gas meters a galvanic separation is needed per ATEX standards	

Digital outputs (optocoupled NPN transistor type for DIN 43864)	
Maximum applicable voltage:	27 Vdc
Maximum switchable current:	27 mA

INPUT & OUTPUTS CONNECTION EXAMPLE

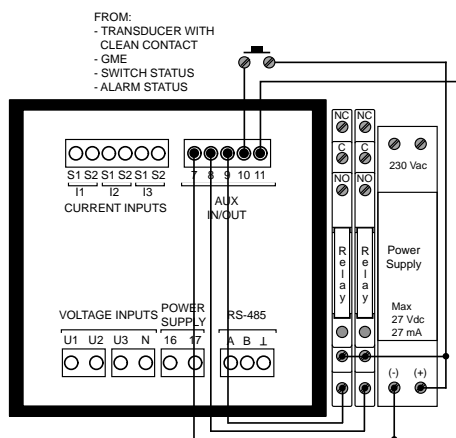
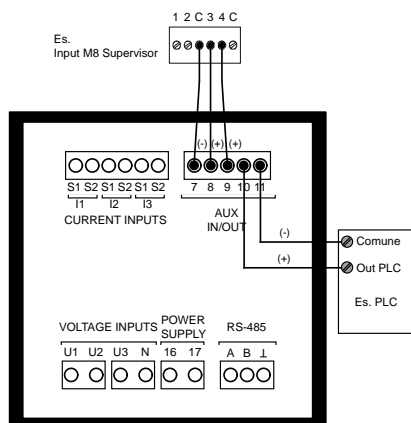

ALARM SET UP EXAMPLE

To ensure that the exit "digital out 1" remain excited for the alarm duration (latching) when average active power (MEAS 344) exceeds the value of 100 kW, hysteresis, 5% and latency of 5 seconds set the parameters such as table:

ALARM 1 / A	MODE (note n.2)	Normal, 1-OF-3, 3-OF-3, DERIV, UNBAL	NORMAL
	TYPE (note n.3)	MAX, MIN	MAX
	MEAS (note n.4)	Controlled measure. See table n.1 for register selection	344
ALARM 1 / B	THRE (note n.4)	Threshold value	100000
	HYST	1...100 (%)	5
	DELAY	1...99 (seconds)	5
	AVG (note n.5)	1...99 (seconds)	1
DIGITAL OUT 1	OUT (note n.6)	Normal, Hold, Pulse-L, Pulse-S	NORMAL
	MODE	PULSE, ALARM, REMOTE	ALARM
	POLARITY	NO, NC	NO

To ensure that the exit "digital out 1" remain excited for the alarm duration (latching) when average active power (MEAS 344) goes down the value of 90 kW, hysteresis, 5% and latency of 5 seconds set the parameters such as table:

ALARM 2 / A	MODE (note n.2)	Normal, 1-OF-3, 3-OF-3, DERIV, UNBAL	NORMAL
	TYPE (note n.3)	MAX, MIN	MIN
	MEAS (note n.4)	Controlled measure. See table n.1 for register selection	344
ALARM 2 / B	THRE (note n.4)	Threshold value	90000
	HYST	1...100 (%)	5
	DELAY	1...99 (seconds)	5
	AVG (note n.5)	1...99 (seconds)	1
DIGITAL OUT 2	OUT (note n.6)	Normal, Hold, Pulse-L, Pulse-S	NORMAL
	MODE	PULSE, ALARM, REMOTE	ALARM
	POLARITY	NO, NC	NO

MESSAGE "CFG ERROR"

During the set up operation a "CFG ERROR" message could appear. This means that some wrong parameters are typed. To restore the factory default settings use the following procedure (RESTORE FACTORY SETTING) seguire la seguente procedura:



Once this procedure is done the meter is configured with its factory default settings. Stored data will remain after the restore operation.

VOLTAGE AND ELECTRIC CURRENT CONNECTION

Voltage connection: Use cables with max cross-section of 2,5 mm² if stranded 4 mm² if rigid and connect them to the clamps marked VOLTAGE INPUT on the instrument according to the applicable diagrams that follow.

Current connection

It is necessary to use external CTs with a primary rating adequate to the load to be metered and with a 5A or 1A secondary rating. The number of CTs to be used (1 or 3) depends upon the type of network. Connect the CT output(s) to the terminals marked I1, I2, I3 (CURRENT INPUT) of the instrument according to the applicable diagrams that follow. Use cables with cross-section adequate to the VA rating of the CT and to the distance to be covered. The max cross-section for the terminals is 2,5 mm² if stranded and 4 mm² if rigid.

N.B. The CT secondary must always be in short circuit when not connected to the instrument in order to avoid damages and risks for the operator.

Warning: The phase relationship of voltage and current connections, the P1-P2 direction and the S1-S2 connection of the CT(s) must be correct. **Earth only CT on L1 as shown in diagram** (CT's are internally linked). Disregard of this warning or of wiring diagram leads to major measurement errors.

4W Star (4 wire) 3PH-4W

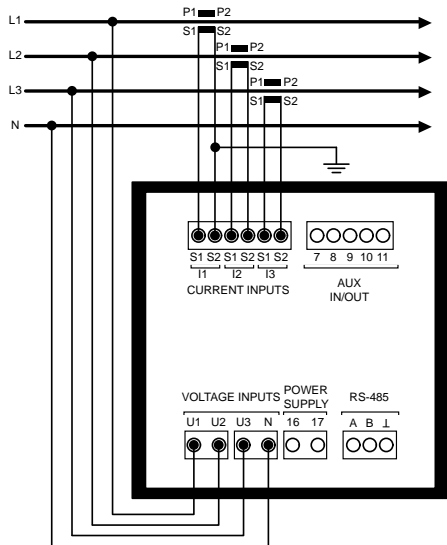

SINGLE PHASE 1PH-2W

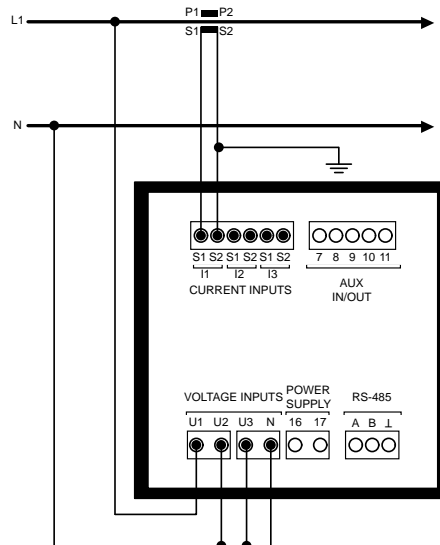

3W Delta (3 wire) 3PH-3W-2CT

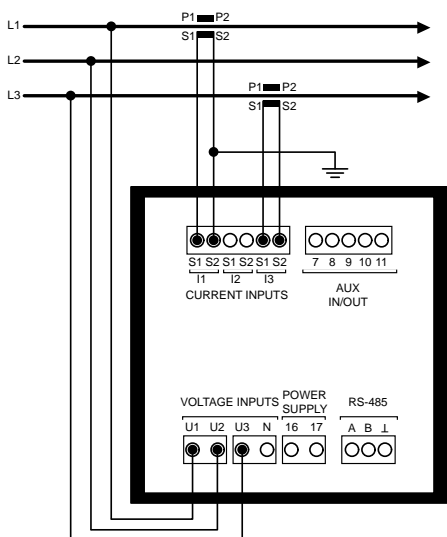

BI-PHASE 2PH-2W

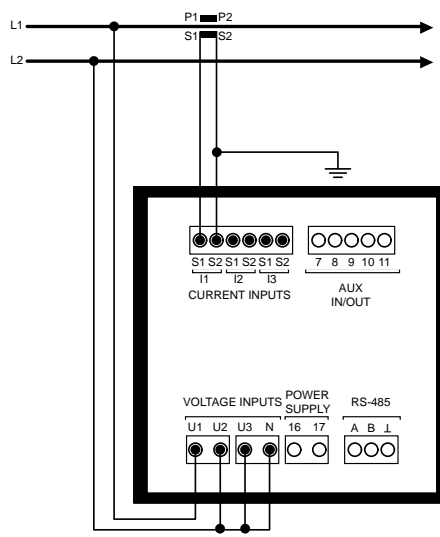

POWER SUPPLY AND SERIAL LINE CONNECTION

The instrument is fitted with a separate power supply. The power supply terminals are numbered (16) and (17). Use cables with max cross-section of 2,5 mm² if stranded, 4 mm² if rigid.

